

PNP Silicon AF Transistors

BCP 51
... BCP 53

- For AF driver and output stages
- High collector current
- Low collector-emitter saturation voltage
- Complementary types: BCP 54 ... BCP 56 (NPN)

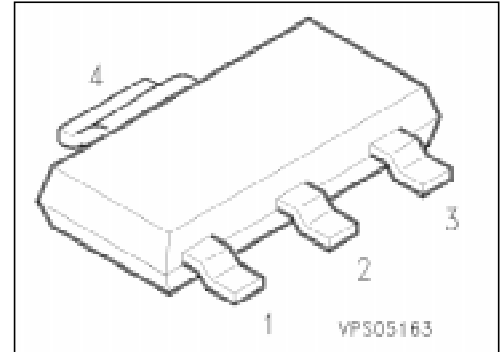

Type	Marking	Ordering Code (tape and reel)	Pin Configuration				Package ¹⁾
			1	2	3	4	
BCP 51	BCP 51	Q62702-C2107	B	C	E	C	SOT-223
BCP 51-10	BCP 51-10	Q62702-C2109					
BCP 51-16	BCP 51-16	Q62702-C2110					
BCP 52	BCP 52	Q62702-C2146					
BCP 52-10	BCP 52-10	Q62702-C2112					
BCP 52-16	BCP 52-16	Q62702-C2113					
BCP 53	BCP 53	Q62702-C2147					
BCP 53-10	BCP 53-10	Q62702-C2115					
BCP 53-16	BCP 53-16	Q62702-C2116					

¹⁾ For detailed information see chapter Package Outlines.

Maximum Ratings

Parameter	Symbol	Values			Unit
		BCP 51	BCP 52	BCP 53	
Collector-emitter voltage $R_{BE} \leq 1 \text{ k}\Omega$	V_{CE0}	45	60	80	V
	V_{CER}	45	60	100	
Collector-base voltage	V_{CB0}	45	60	100	
Emitter-base voltage	V_{EB0}	5			
Collector current	I_C	1			A
Peak collector current	I_{CM}	1.5			
Base current	I_B	100			mA
Peak base current	I_{BM}	200			
Total power dissipation, $T_s = 124 \text{ }^\circ\text{C}^1)$	P_{tot}	1.5			W
Junction temperature	T_j	150			$^\circ\text{C}$
Storage temperature range	T_{stg}	- 65 ... + 150			

Thermal Resistance

Junction - ambient ¹⁾	$R_{th JA}$	≤ 72	K/W
Junction - soldering point	$R_{th JS}$	≤ 17	

¹⁾ Package mounted on epoxy pcb 40 mm × 40 mm × 1.5 mm/6 cm² Cu.

Electrical Characteristics

at $T_A = 25\text{ °C}$, unless otherwise specified.

Parameter	Symbol	Values			Unit
		min.	typ.	max.	

DC characteristics

Collector-emitter breakdown voltage $I_C = 10\text{ mA}$, $I_B = 0$	$V_{(BR)CE0}$	BCP 51	45	–	–	V
		BCP 52	60	–	–	
		BCP 53	80	–	–	
Collector-base breakdown voltage $I_C = 100\text{ }\mu\text{A}$, $I_B = 0$	$V_{(BR)CB0}$	BCP 51	45	–	–	
		BCP 52	60	–	–	
		BCP 53	100	–	–	
Emitter-base breakdown voltage $I_E = 10\text{ }\mu\text{A}$, $I_C = 0$	$V_{(BR)EB0}$		5	–	–	
Collector-base cutoff current $V_{CB} = 30\text{ V}$, $I_E = 0$ $V_{CB} = 30\text{ V}$, $I_E = 0$, $T_A = 150\text{ °C}$	I_{CB0}		–	–	100	nA
				–	–	20
Emitter-base cutoff current $V_{EB} = 5\text{ V}$, $I_C = 0$	I_{EB0}		–	–	10	μA
DC current gain ¹⁾ $I_C = 5\text{ mA}$, $V_{CE} = 2\text{ V}$ $I_C = 150\text{ mA}$, $V_{CE} = 2\text{ V}$	h_{FE}	BCP 51/BCP 52/BCP 53	25	–	–	–
		BCP 51/BCP 52/BCP 53-10	40	–	250	
		BCP 51/BCP 52/BCP 53-16	63	100	160	
			100	160	250	
$I_C = 500\text{ mA}$, $V_{CE} = 2\text{ V}$			25	–	–	
Collector-emitter saturation voltage ¹⁾ $I_C = 500\text{ mA}$, $I_B = 50\text{ mA}$	V_{CEsat}		–	–	0.5	V
Base-emitter voltage ¹⁾ $I_C = 500\text{ mA}$, $V_{CE} = 2\text{ V}$	V_{BE}		–	–	1	

AC characteristics

Transition frequency $I_C = 50\text{ mA}$, $V_{CE} = 10\text{ V}$, $f = 100\text{ MHz}$	f_T	–	125	–	MHz
--	-------	---	-----	---	-----

¹⁾ Pulse test conditions: $t \leq 300\text{ }\mu\text{s}$, $D = 2\%$.

Total power dissipation $P_{tot} = f(T_A^*; T_S)$

* Package mounted on epoxy

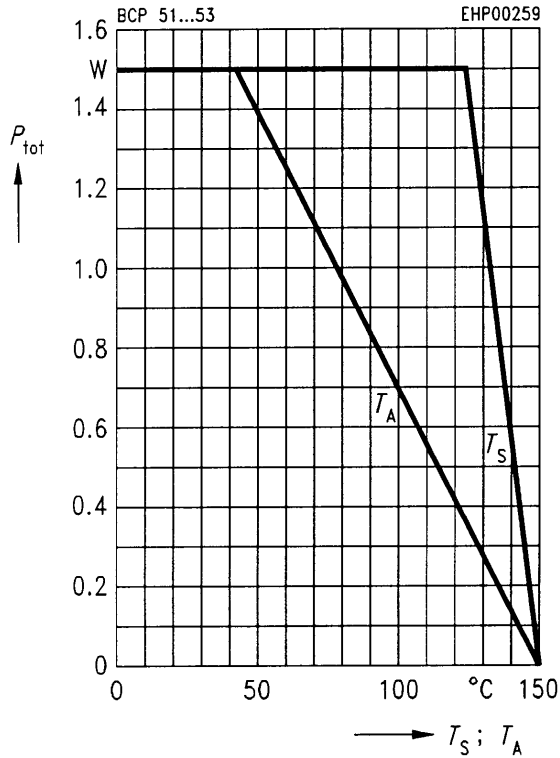

Transition frequency $f_T = f(I_C)$

$V_{CE} = 10\text{ V}$

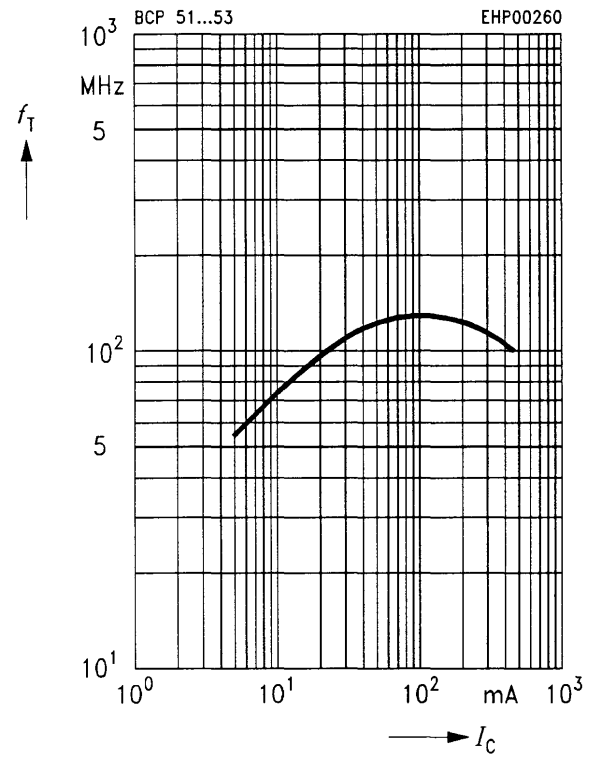

DC current gain $h_{FE} = f(I_C)$

$V_{CE} = 2\text{ V}$

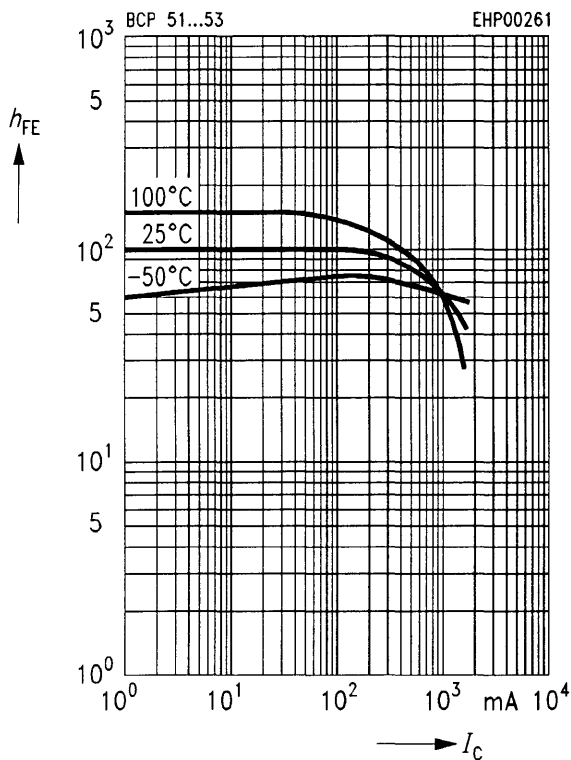

Collector cutoff current $I_{CBO} = f(T_A)$

$V_{CB} = 30\text{ V}$

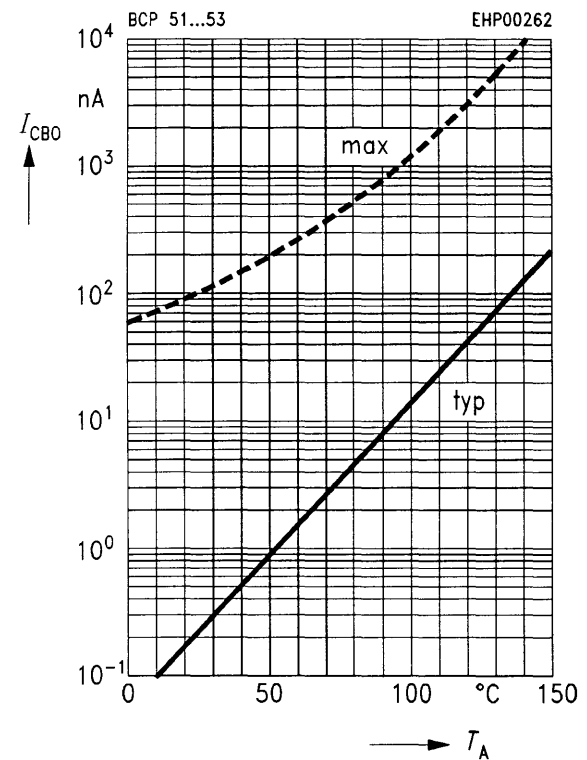

Base-emitter saturation voltage

$I_C = f(V_{BEsat})$

$h_{FE} = 10$

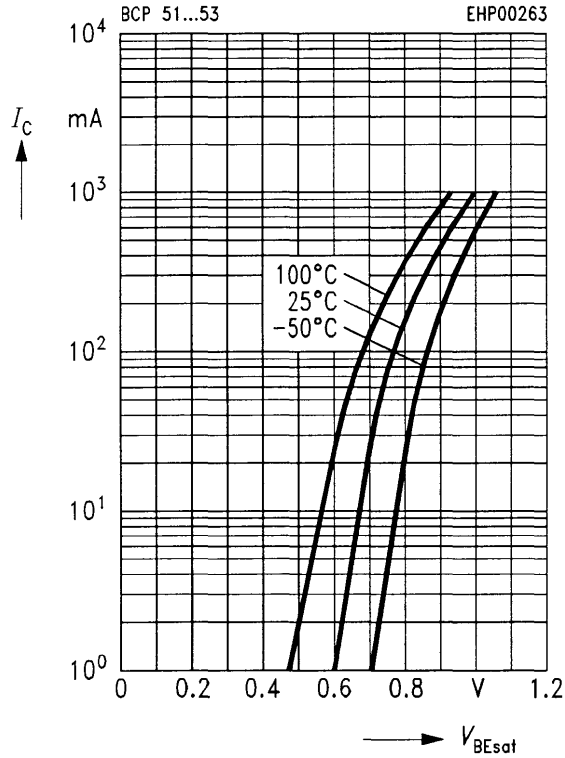

Collector-emitter saturation voltage

$I_C = f(V_{CEsat})$

$h_{FE} = 10$

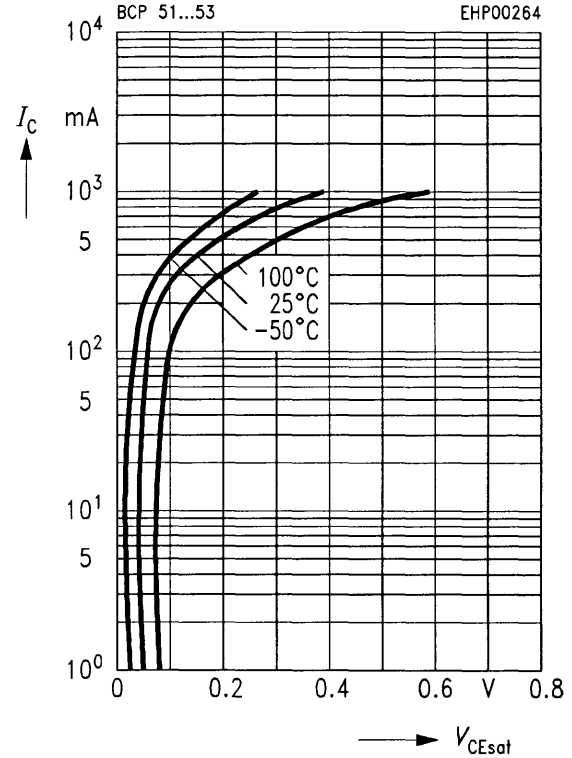

Permissible pulse load $P_{tot max}/P_{tot DC} = f(t_p)$

