



STS4DNF60L

N-CHANNEL 60V - 0.045 Ω - 4A SO-8 STripFET™ POWER MOSFET

TYPE	V _{DSS}	R _{DS(on)}	I _D
STS4DNF60L	60 V	<0.055 Ω	4 A

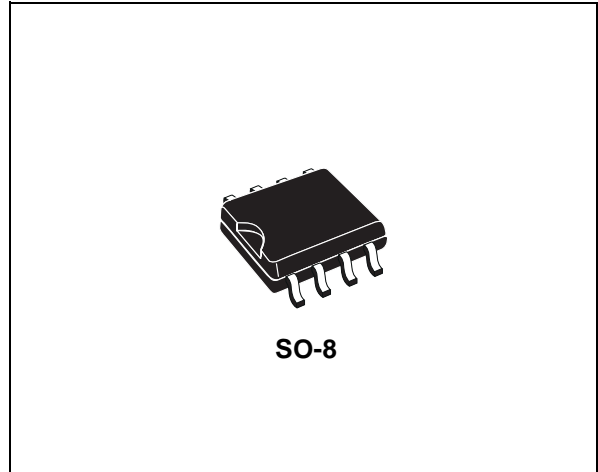
- TYPICAL R_{DS(on)} = 0.045 Ω
- STANDARD OUTLINE FOR EASY AUTOMATED SURFACE MOUNT ASSEMBLY
- LOW THRESHOLD DRIVE

DESCRIPTION

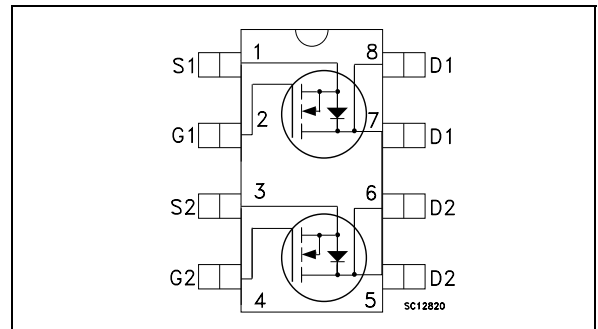
This Power MOSFET is the latest development of STMicroelectronics unique "Single Feature Size™" strip-based process. The resulting transistor shows extremely high packing density for low on-resistance, rugged avalanche characteristics and less critical alignment steps therefore a remarkable manufacturing reproducibility.

APPLICATIONS

- DC MOTOR DRIVE
- DC-DC CONVERTERS
- BATTERY MANAGEMENT IN NOMADIC EQUIPMENT
- POWER MANAGEMENT IN PORTABLE/DESKTOP PCs



INTERNAL SCHEMATIC DIAGRAM



ABSOLUTE MAXIMUM RATINGS

Symbol	Parameter	Value	Unit
V _{DS}	Drain-source Voltage (V _{GS} = 0)	60	V
V _{DGR}	Drain-gate Voltage (R _{GS} = 20 kΩ)	60	V
V _{GS}	Gate- source Voltage	± 15	V
I _D	Drain Current (continuous) at T _C = 25°C Single Operation	4	A
	Drain Current (continuous) at T _C = 100°C Single Operation	2.5	A
I _{DM} (●)	Drain Current (pulsed)	16	A
P _{tot}	Total Dissipation at T _C = 25°C Dual Operation	2.5	W
	Total Dissipation at T _C = 25°C Single Operation	1.6	W

(●) Pulse width limited by safe operating area.

STS4DNF60L

THERMAL DATA

Rthj-amb	(*)Thermal Resistance Junction-ambient	Single Operation	78	°C/W
		Dual Operating	62.5	°C/W
T _j	Thermal Operating Junction-ambient		150	°C
T _{stg}	Storage Temperature		-55 to 175	°C

(*) Mounted on FR-4 board (t ≤ 10 sec.)

ELECTRICAL CHARACTERISTICS (T_{case} = 25 °C unless otherwise specified)

OFF

Symbol	Parameter	Test Conditions	Min.	Typ.	Max.	Unit
V _{(BR)DSS}	Drain-source Breakdown Voltage	I _D = 250 μA, V _{GS} = 0	60			V
I _{DSS}	Zero Gate Voltage Drain Current (V _{GS} = 0)	V _{DS} = Max Rating V _{DS} = Max Rating T _C = 125°C			1 10	μA μA
I _{GSS}	Gate-body Leakage Current (V _{DS} = 0)	V _{GS} = ± 15V			±100	nA

ON (1)

Symbol	Parameter	Test Conditions	Min.	Typ.	Max.	Unit
V _{GS(th)}	Gate Threshold Voltage	V _{DS} = V _{GS} I _D = 250 μA	1	1.7	2.5	V
R _{DS(on)}	Static Drain-source On Resistance	V _{GS} = 10 V I _D = 2 A V _{GS} = 4.5 V I _D = 2 A		0.045 0.050	0.055 0.065	Ω Ω

DYNAMIC

Symbol	Parameter	Test Conditions	Min.	Typ.	Max.	Unit
g _{fs} (*)	Forward Transconductance	V _{DS} > I _{D(on)} × R _{DS(on)} max I _D = 2 A		7		S
C _{iss}	Input Capacitance	V _{DS} = 25V, f = 1 MHz, V _{GS} = 0		1030		pF
C _{oss}	Output Capacitance			140		pF
C _{rss}	Reverse Transfer Capacitance			40		pF

ELECTRICAL CHARACTERISTICS (continued)

SWITCHING ON

Symbol	Parameter	Test Conditions	Min.	Typ.	Max.	Unit
$t_{d(on)}$ t_r	Turn-on Delay Time Rise Time	$V_{DD} = 30\text{ V}$ $I_D = 2.5\text{ A}$ $R_G = 4.7\ \Omega$ $V_{GS} = 4.5\text{ V}$ (Resistive Load, Figure 3)		15 28		ns ns
Q_g Q_{gs} Q_{gd}	Total Gate Charge Gate-Source Charge Gate-Drain Charge	$V_{DD} = 48\text{ V}$ $I_D = 4\text{ A}$ $V_{GS} = 4.5\text{ V}$		15 4 4		nC nC nC

SWITCHING OFF

Symbol	Parameter	Test Conditions	Min.	Typ.	Max.	Unit
$t_{r(Voff)}$ t_f t_c	Turn-off Delay Time Fall Time Cross-over Time	$V_{clamp} = 48\text{ V}$ $I_D = 5\text{ A}$ $R_G = 4.7\ \Omega$, $V_{GS} = 4.5\text{ V}$ (Inductive Load, Figure 5)		15 20 20	25	ns ns ns

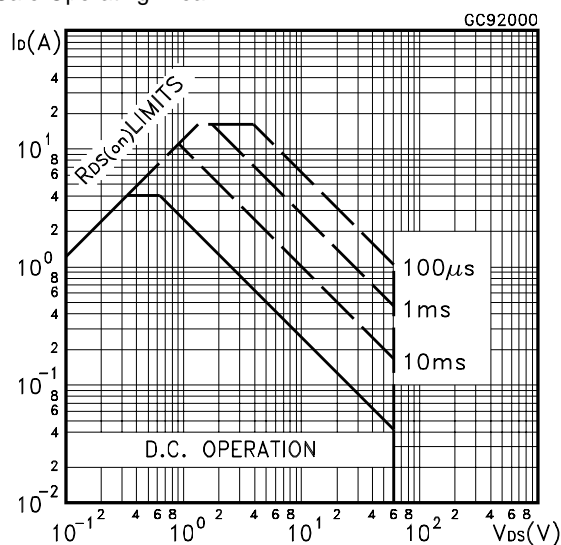
SOURCE DRAIN DIODE

Symbol	Parameter	Test Conditions	Min.	Typ.	Max.	Unit
I_{SD} $I_{SDM} (\bullet)$	Source-drain Current Source-drain Current (pulsed)				4 16	A A
$V_{SD} (*)$	Forward On Voltage	$I_{SD} = 4\text{ A}$ $V_{GS} = 0$			1.2	V
t_{rr} Q_{rr} I_{RRM}	Reverse Recovery Time Reverse Recovery Charge Reverse Recovery Current	$I_{SD} = 4\text{ A}$ $di/dt = 100\text{ A}/\mu\text{s}$ $V_{DD} = 20\text{ V}$ $T_j = 150^\circ\text{C}$ (see test circuit, Figure 5)		85 85 2		ns nC A

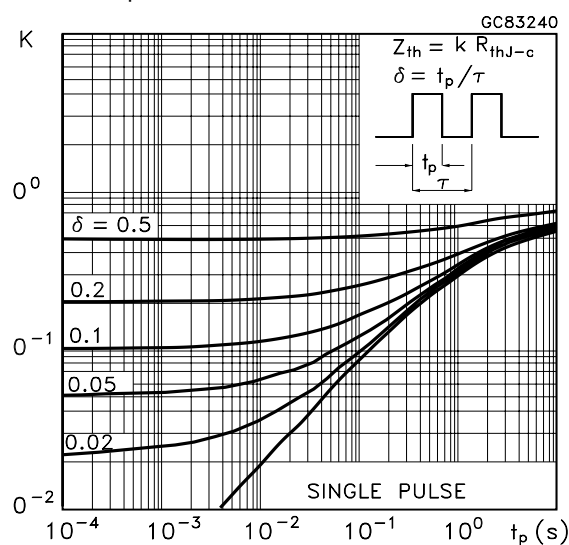
(*) Pulsed: Pulse duration = 300 μs , duty cycle 1.5 %.

(\bullet) Pulse width limited by safe operating area.

Safe Operating Area

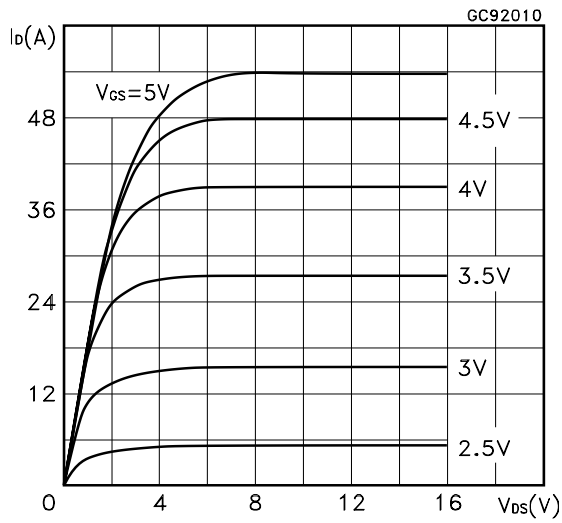


Thermal Impedance

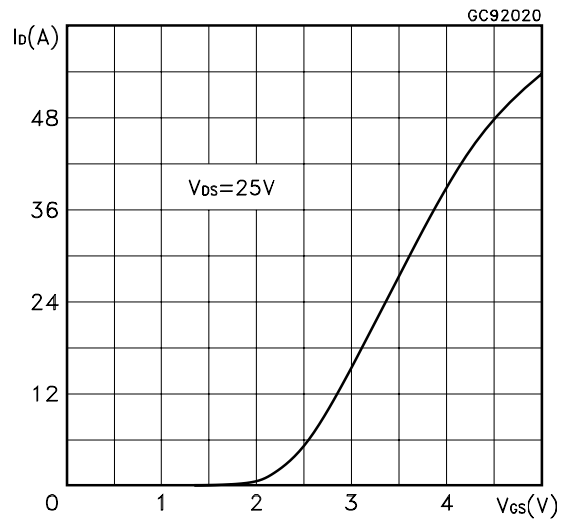


STS4DNF60L

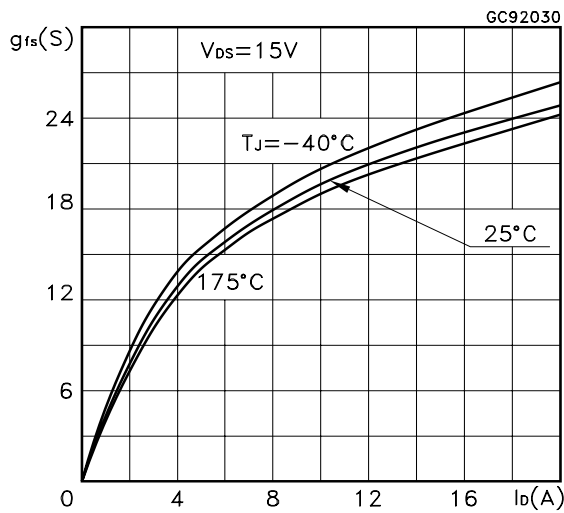
Output Characteristics



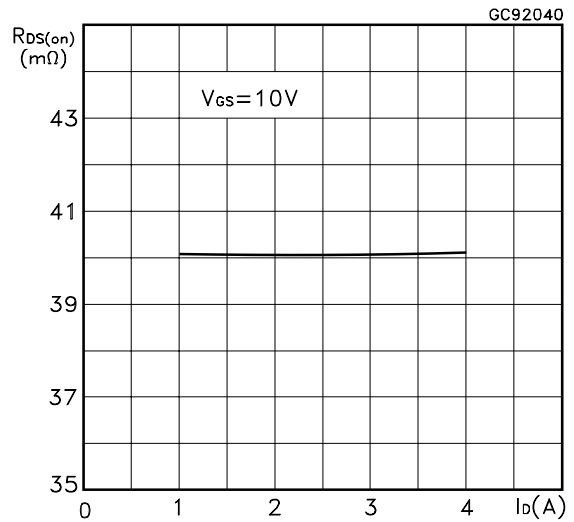
Transfer Characteristics



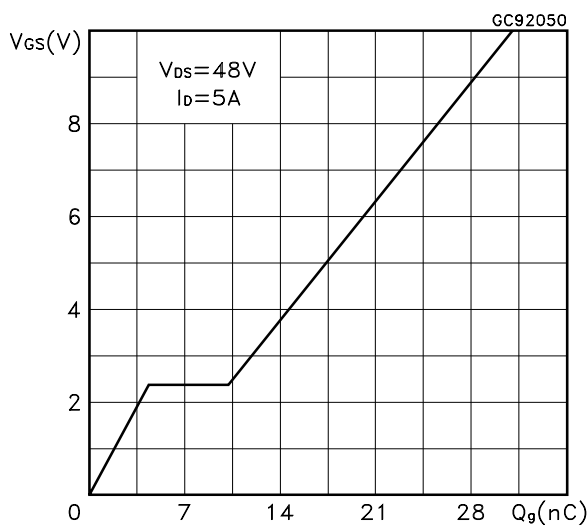
Transconductance



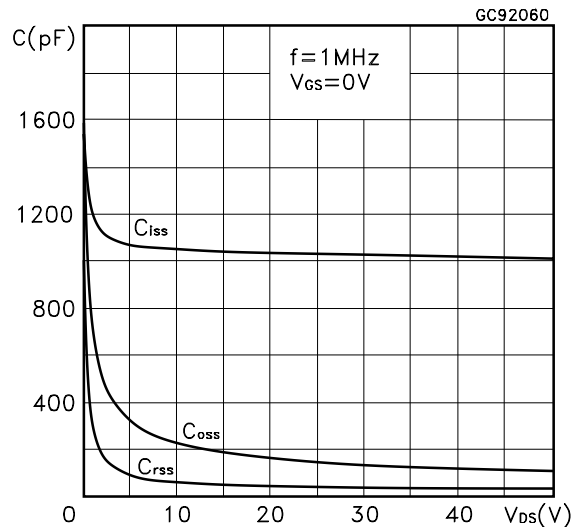
Static Drain-source On Resistance



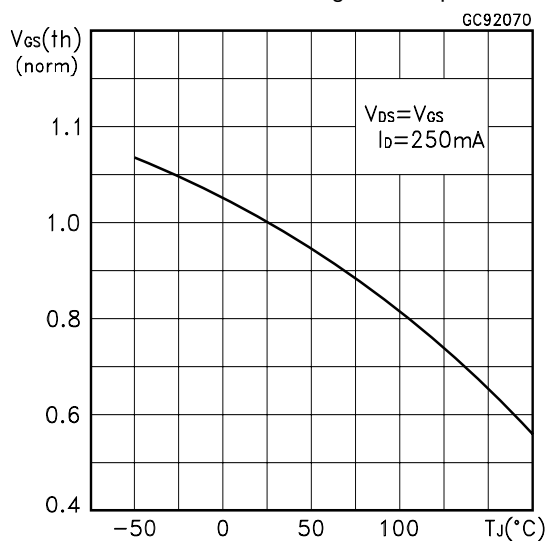
Gate Charge vs Gate-source Voltage



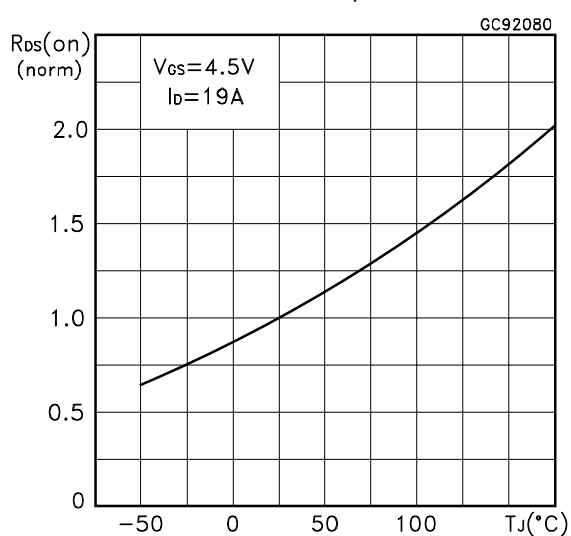
Capacitance Variations



Normalized Gate Threshold Voltage vs Temperature



Normalized on Resistance vs Temperature



Source-drain Diode Forward Characteristics

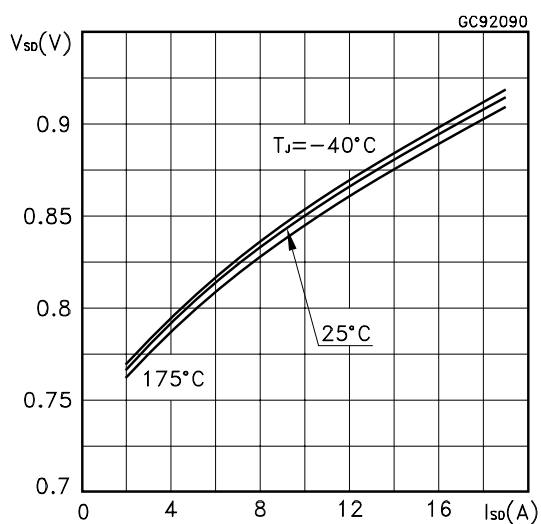


Fig. 1: Unclamped Inductive Load Test Circuit



Fig. 2: Unclamped Inductive Waveform



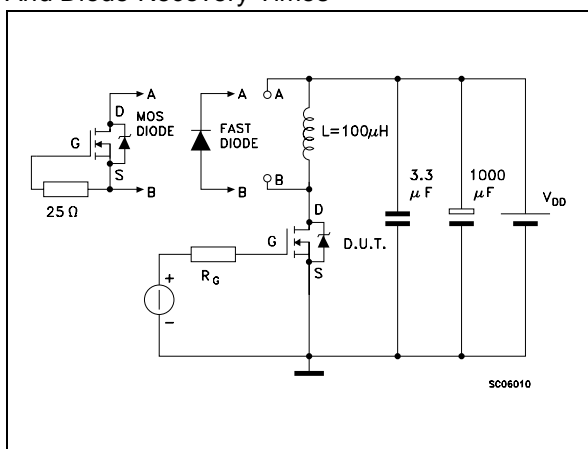
Fig. 3: Switching Times Test Circuits For Resistive Load



Fig. 4: Gate Charge test Circuit

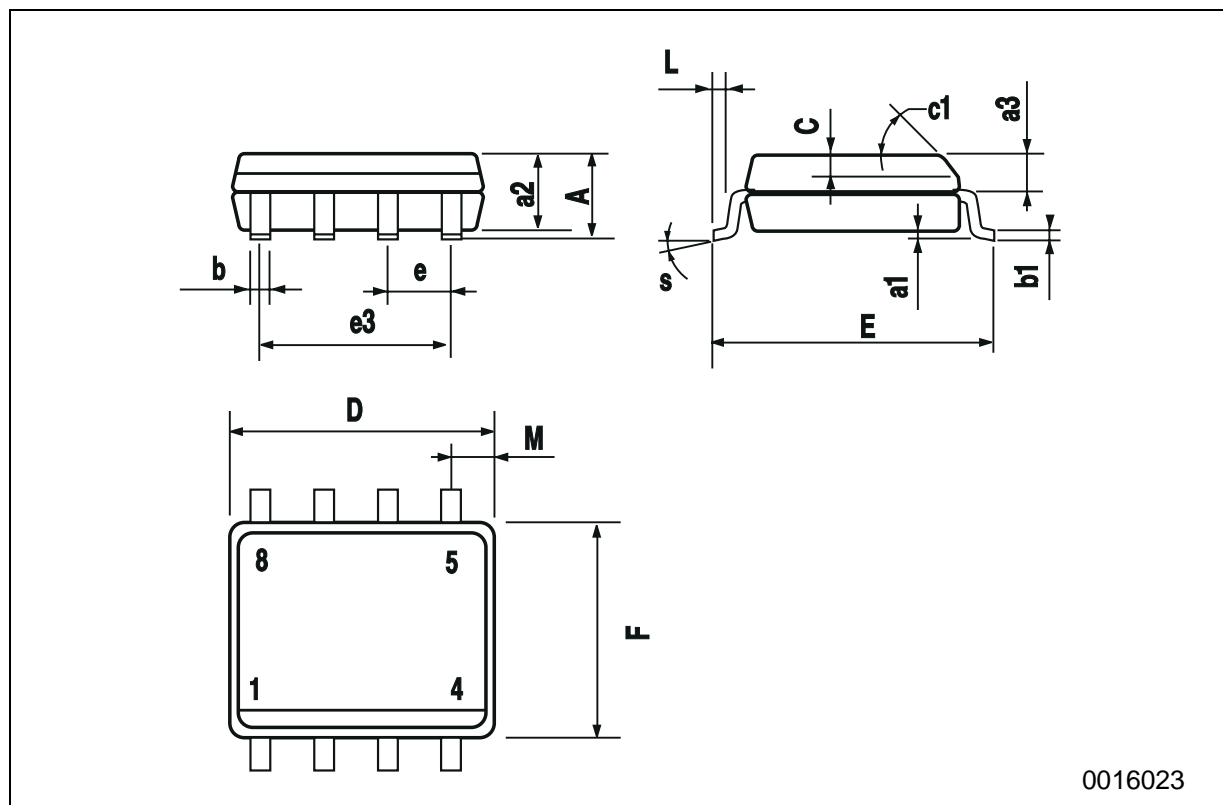


Fig. 5: Test Circuit For Inductive Load Switching And Diode Recovery Times



SO-8 MECHANICAL DATA

DIM.	mm			inch		
	MIN.	TYP.	MAX.	MIN.	TYP.	MAX.
A			1.75			0.068
a1	0.1		0.25	0.003		0.009
a2			1.65			0.064
a3	0.65		0.85	0.025		0.033
b	0.35		0.48	0.013		0.018
b1	0.19		0.25	0.007		0.010
C	0.25		0.5	0.010		0.019
c1	45 (typ.)					
D	4.8		5.0	0.188		0.196
E	5.8		6.2	0.228		0.244
e		1.27			0.050	
e3		3.81			0.150	
F	3.8		4.0	0.14		0.157
L	0.4		1.27	0.015		0.050
M			0.6			0.023
S	8 (max.)					



0016023

Information furnished is believed to be accurate and reliable. However, STMicroelectronics assumes no responsibility for the consequences of use of such information nor for any infringement of patents or other rights of third parties which may result from its use. No license is granted by implication or otherwise under any patent or patent rights of STMicroelectronics. Specifications mentioned in this publication are subject to change without notice. This publication supersedes and replaces all information previously supplied. STMicroelectronics products are not authorized for use as critical components in life support devices or systems without express written approval of STMicroelectronics.

The ST logo is registered trademark of STMicroelectronics
© 2001 STMicroelectronics - All Rights Reserved

All other names are the property of their respective owners.

STMicroelectronics GROUP OF COMPANIES
Australia - Brazil - China - Finland - France - Germany - Hong Kong - India - Italy - Japan - Malaysia - Malta - Morocco -
Singapore - Spain - Sweden - Switzerland - United Kingdom - U.S.A.

<http://www.st.com>

This datasheet has been download from:

www.datasheetcatalog.com

Datasheets for electronics components.