

TD-A10

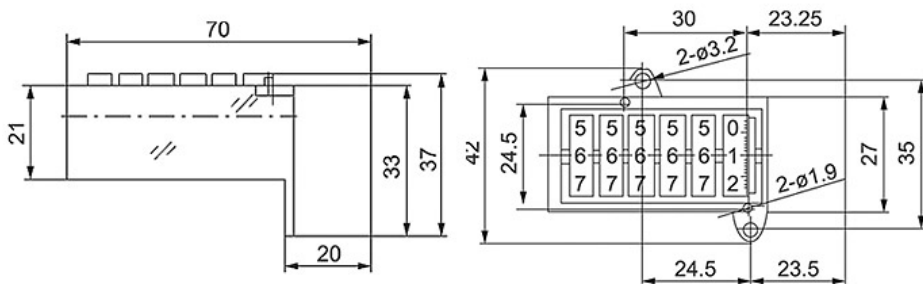

TD-A11

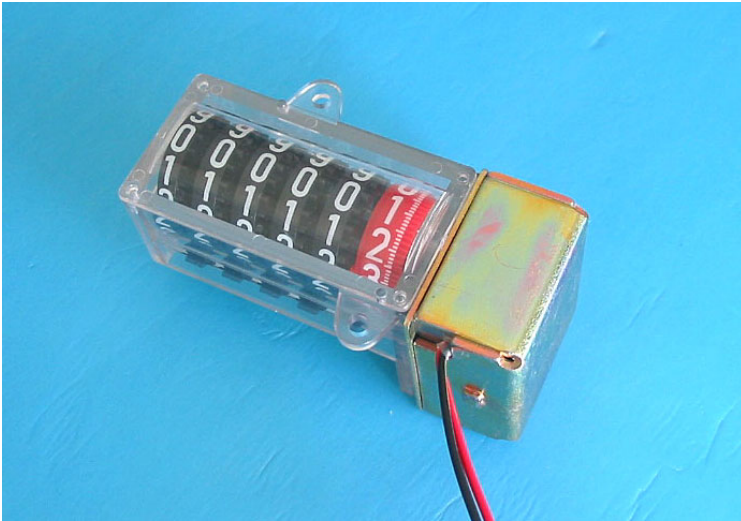
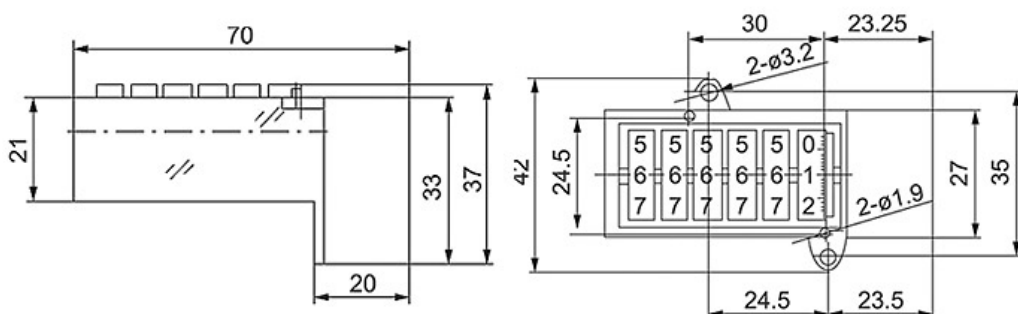
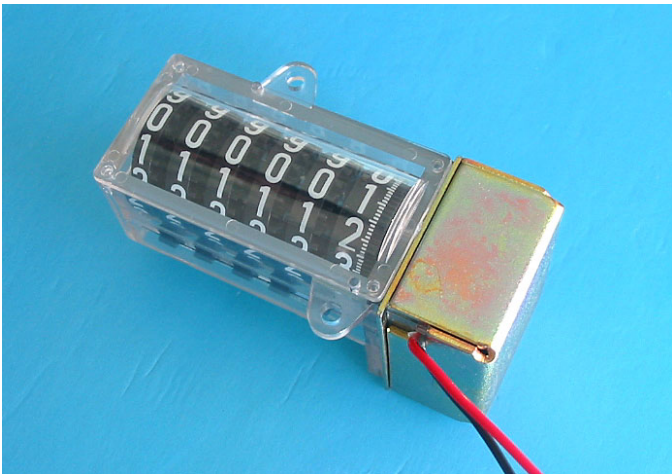

TD-A20

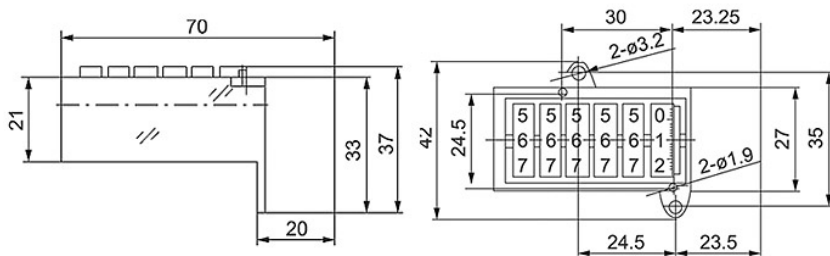
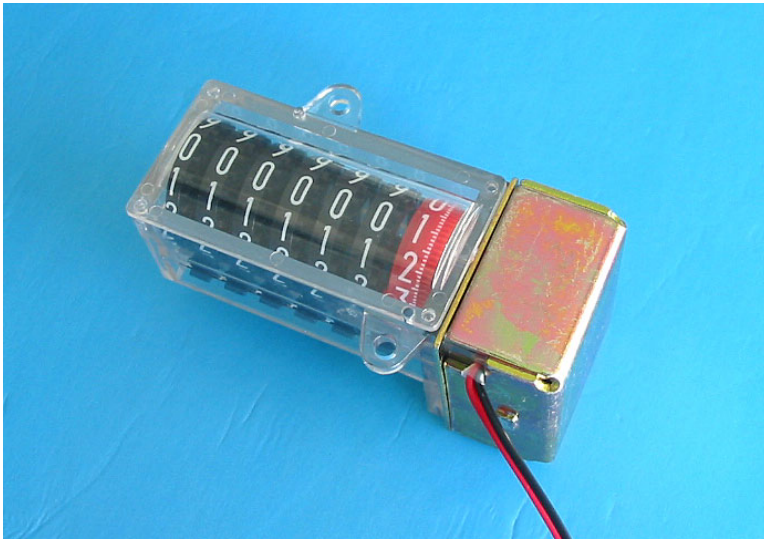

TD-AF10

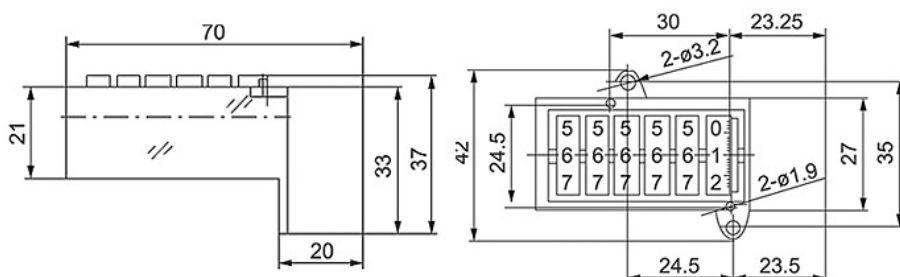
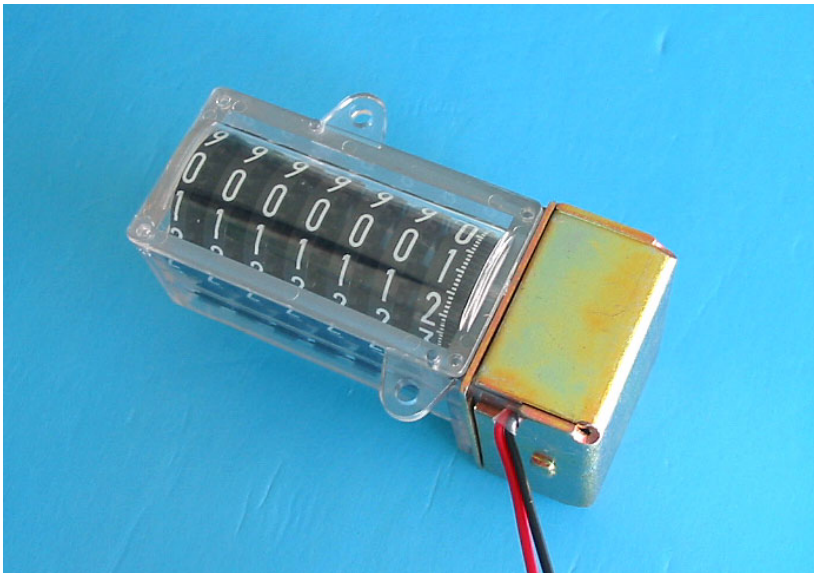

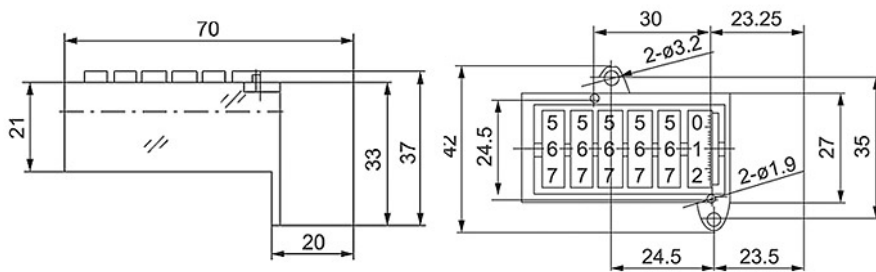
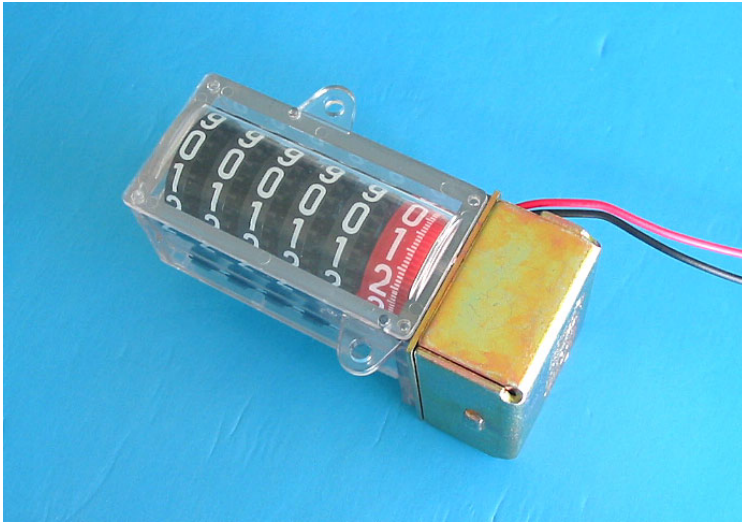

Work voltage:	2.5V-6.0V
DC impedance:	450Ω±50Ω/23℃
Applicable pulse width:	≥50ms
Applicable frequency:	≤6Hz
Deferent moment:	≥60μNm/5V
Work temperature:	-35℃-+70℃
Use life:	pulse exceed a hundred million times (more ten years)
Antimagnetic capability:	Accord GB/T17215 standard request
Other technical condition:	Accord JB5459-91 standard request
Applicable ammeter constant:	800/1600/3200/6400imp/kw-h.80:1
Constant:	80:1 100:1 200:1 400:1 800:1
Make to order:	Special specification